

Natura™ Inert Gas Fire Suppression System

Effective: April 2020
K-38-2000 Rev AA

Flexible. Efficient. Sustainable.

Kidde Fire Systems introduces the Natura™ Inert Gas System (Natura IGS) for fire suppression - an environmentally safe, competitive, and cost-effective choice for protecting assets including those in commercial, light industrial, and heavy industrial applications. With global approvals and a selection of agents and hardware profiles, Natura IGS can be the natural choice for inert gas fire suppression systems.

Environmentally safe

- Uses naturally occurring gases.
- Zero Global Warming Potential (GWP)
- Zero Ozone Depletion Potential (ODP)

Wide range of applications - broad opportunity

- Data Centers
- Hospitals & Medical Facilities
- Libraries and Archives
- Museums & Cultural Heritage Buildings
- Petroleum, Oil & Gas Facilities
- Pharmaceutical Manufacturing
- Telecommunication Facilities
- Others

Choice of agents and hardware profile - suits regional requirements and filling capabilities

- Appropriateness of pure & blended inert gases for multiple fire types broadens application scope
 - Class A Surface fires
 - Class B Hydrocarbon fires
 - Class C Electrical fires
- System pressures suitable for regional capabilities
 - 200 bar
 - 300 bar
- Cylinder sizes to suit floor space
 - 80 Liter
 - 140 Liter (Global version available; DOT in future)
- Nozzles types add design & installation flexibility
 - 180° (Pendant or upright style)
 - 360° (Pendant or upright style)



Specify and ship worldwide with confidence globally certified by:

- Transportation
 - TPED and/or UN/DOT
- Performance
 - Loss Prevention Certification Board, LPCB
 - FM Approved (IG-100, IG-55)
- Materials
 - Construction Products Regulation, CPR
 - Nationally Recognized Test Labs (NRTL) in process

Superior valve design regulates mass flow, maintains pressure & shuts off at 55 bar (no flow condition) - enables lower cost installation

- In most cases, schedule 40 pipe now suitable vs. higher cost Sch 80 or 160 for unregulated systems.
- Regulated flow reduces pressure vent size and therefore cost.

Designed for quick and easy installation

- Pre-fabricated manifolds
- Quick connect actuation tube fittings
- Daisy chained pressure supervision via plug-in interconnections

Wide operating temperature

- Range of -4° to 130°F (-20° to 54°C) allows from hot to cold application environments

Inert Gases

Natura IGS offers two inert gases for use in the fire suppression system. These gases are:

- IG-100: Pure Nitrogen
- IG-55: Gaseous Mixture of 50% Nitrogen and 50% Argon

Hazard Protection

The Natura IGS can be designed to cover a single hazard or multiple hazards from a common cylinder bank.

Single Zone System

The following figure depicts an example of a single zone Natura IGS setup which protects one hazard.

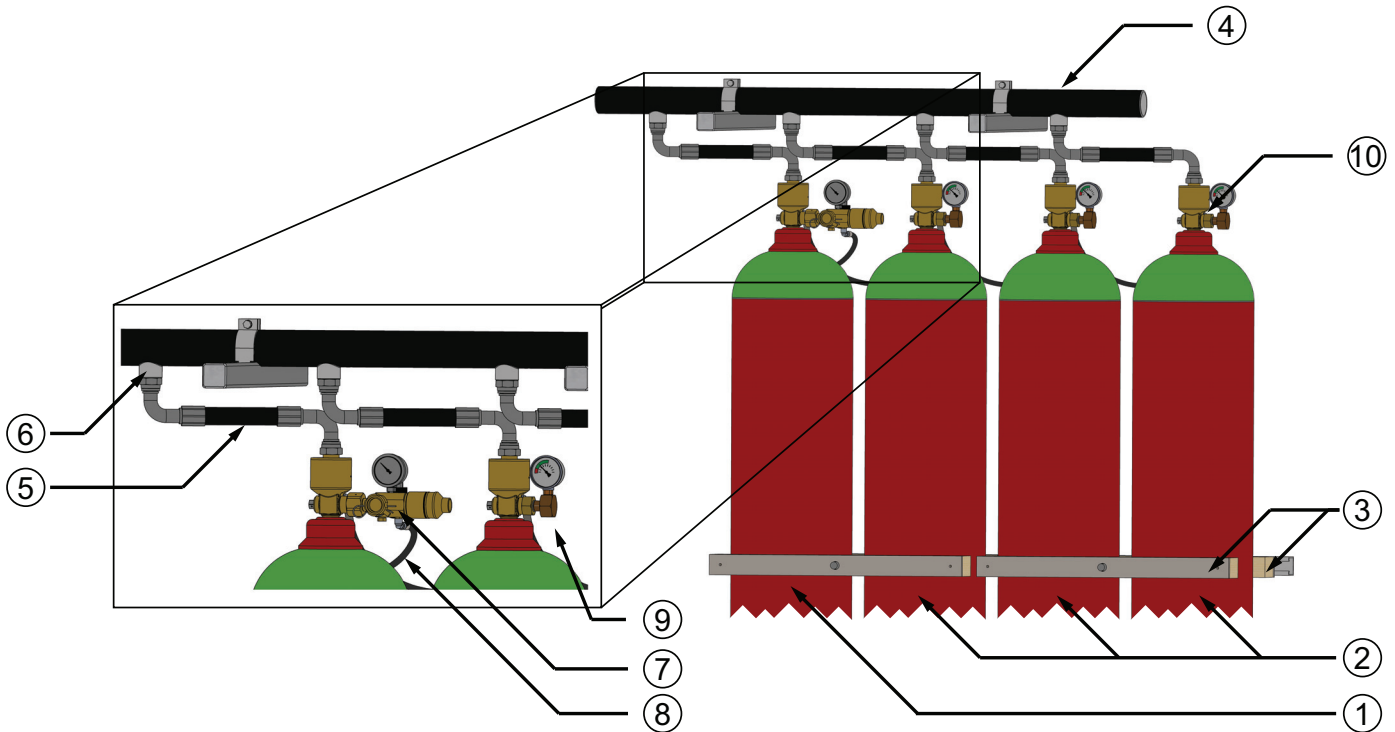

Figure 1. Single Area Cylinder Bank Arrangement

Table 1: Single Area Cylinder Bank Arrangement Components

Item	Description	Item	Description
1	Primary Agent Storage Cylinder and Valve Assembly	6	3/4" BSP Manifold Check Valve
2	Slave Agent Storage Cylinder and Valve Assemblies	7	Release Unit
3	Cylinder Racking Components*	8	Pilot Line Actuation Hose
4	Manifold	9	Slave Cylinder Gauge Assembly
5	Discharge Hose	10	Pilot Line Bleed Valve (on back side)

*This system is depicted with wooden racking components. For single row systems, an alternative option is to use the single cylinder clamp (P/N 01-8131-0000) for each cylinder.

Multi Zone System

Multi zone systems can protect multiple hazards with one bank of cylinders. Multi zone systems require the use of one 2-way pneumatically operated selector valve for each of zone protected. The following depicts an example of a multi-zone Natura IGS setup which protects 3 separate hazard zones.

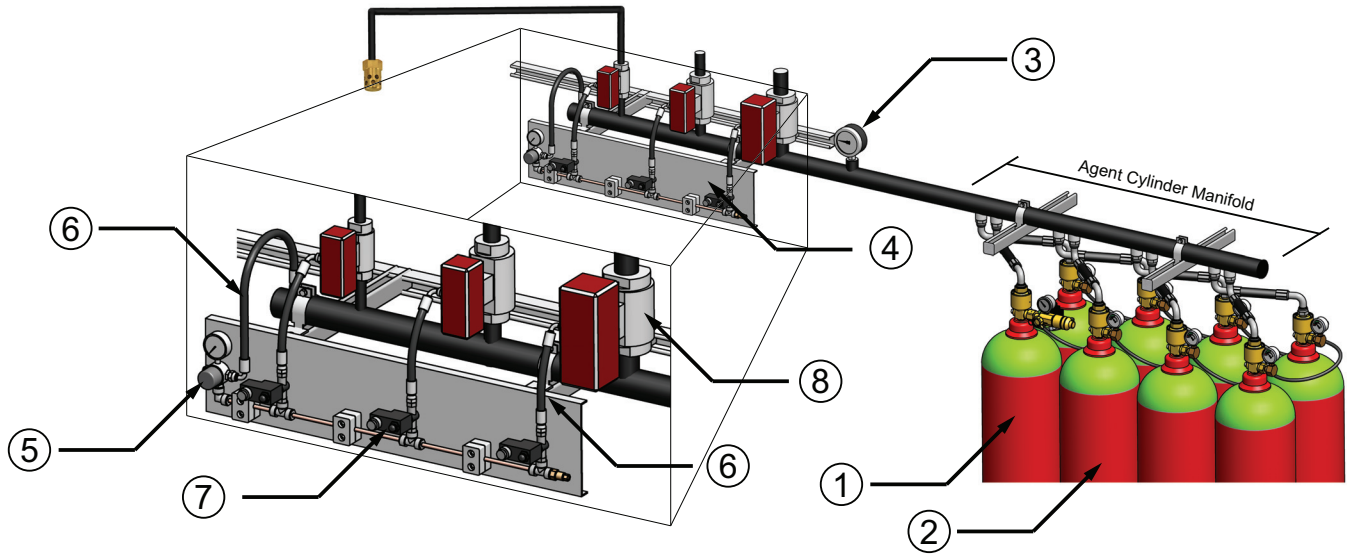

Figure 2. Multi-Hazard System Example

Table 2: Multi-Hazard System Example Component List

Item	Description	Item	Description
1	Primary Agent Storage Cylinder and Valve Assembly	5	Back-Plate Manifold Pressure Regulator
2	Slave Agent Storage Cylinder and Valve Assemblies	6	Back-Plate Manifold Hose
3	Manifold Pressure Gauge (Optional)	7	Back-Plate Manifold Solenoid
4	Back-Plate Manifold	8	Selector Valve

Systems with Concentrations Higher than the LOAEL

When the system is designed with concentration higher than the LOAEL (Lowest Observable Adverse Effect Level) which is 52% agent concentration, the following safety items shall be included in the system:

- Pneumatic Time Delay
- Pneumatic Siren
- Lockout Valve
- Special Signage

A typical system using the above mentioned components is shown below:

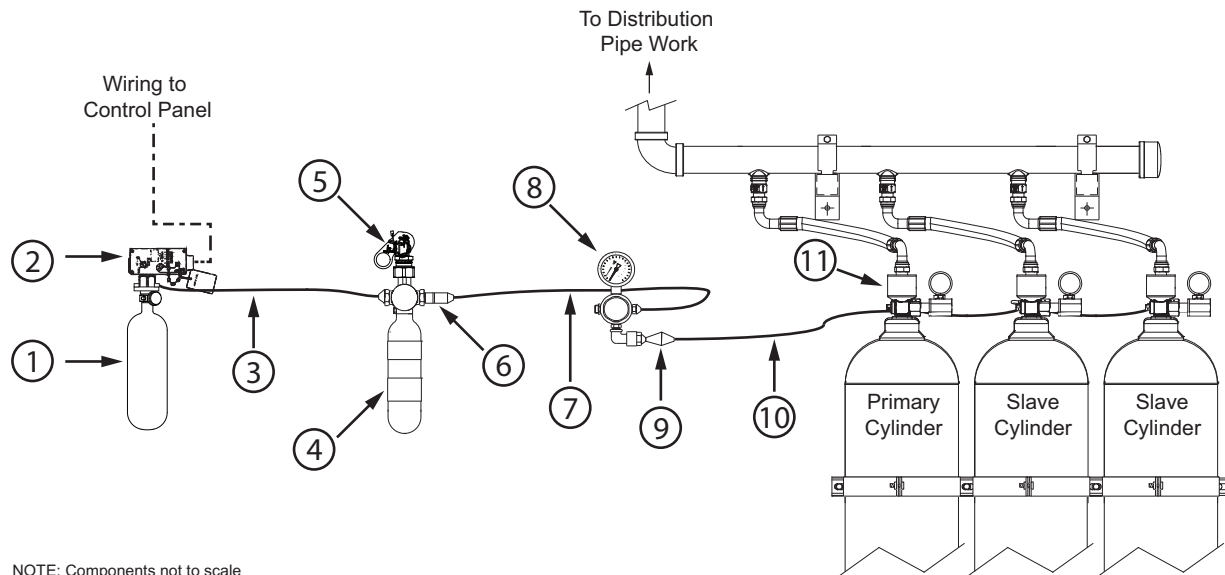

NOTE: Components not to scale

Figure 3. System with Discharge Delay

Table 3: Discharge Delay System Components

Item	Description
1	104 cu. in. Nitrogen Pilot Cylinder
2	Electric Control Head Kit with Control Head Monitor
3	30" Actuation Hose
4	Nitrogen Discharge Delay Kit
5	Lever Operated Control Head
6	3/4" NPS to BSP Adapter
7	Back-Plate Manifold Hose
8	Pressure Regulator
9	BSP to Festo Adapter
10	Pilot Line Actuation Hose
11	1st Cylinder with Slave Gauge

Component Description

Cylinder and Valve Assemblies

The Natura IGS uses seamless steel cylinders compliant with ISO 9809-2 and certified to TPED and/or UN/DOT. System activation and gas discharge is controlled via a pressure operated, mass flow regulated, and pressure controlling valve. The valve is equipped with a safety burst disc in compliance with DOT and TPED requirements and has connection ports for the release unit or slave gauge assembly, pilot line actuation hoses, and an agent discharge port.

Cylinders are available in 80 liters at either 200 bar or 300 bar pressure and 140 liters at 300 bar pressure. All pressures are determined at a filling temperature of 15°C.

Cylinder shells are painted red with green shoulder for easy identification and include agency markings where applicable.

When shipped, cylinder-valve assemblies include an anti-recoil cap and a transport cap as a safety feature designed to prevent uncontrolled, accidental discharge. The outlet cap can be used to perform the system discharge test without discharging agent from the Natura IGS cylinder.

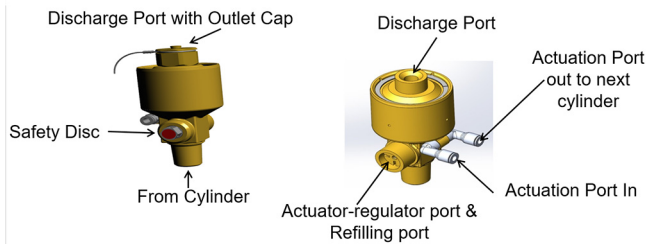

Figure 4. Valve Components

The Natura IGS valve assembly has a 3/4" (20mm) discharge port with BSP male threads.

Note: All cylinders in a system must be of equal size and pressure.

Release Unit

Release units connect to the gauge port of the primary cylinder and activate the Cylinder-Valve to release agent into the system piping. Release units can either be electric operated or a combination manual & electric setup.

Release units have an integral pressure gauge that can be ordered with contacts that are normally open or normally closed under pressure, dependent on jurisdictional requirements.

Release units that include manual operation have a tamper proof seal on the operation pin.

Solenoid Specifications

- Operating Voltage: 24 VDC
- Current Draw: 0.75 Amps

To comply with NFPA 2001 requirements, the solenoid in the Release unit assembly is fixed with tamper proof screws and cannot be removed. However, the Release unit assembly can be detached from the port. For code compliance, such detachment should cause a supervisory signal at the Kidde Fire Systems Suppression control unit.

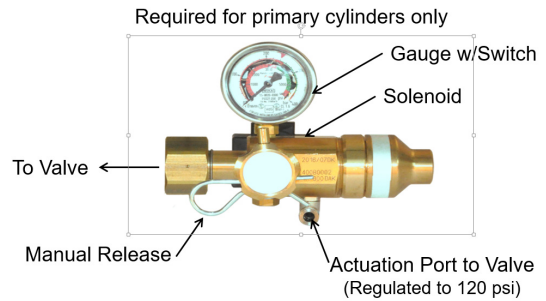

Figure 5. Release Unit

Slave Cylinder Gauge Assembly

Installing a Slave Cylinder Gauge assemblies on a slave cylinder enables monitoring the pressure of the slave cylinders in the system. The Slave Cylinder Gauges assemblies are connected to the Cylinder-Valve gauge port and can have contacts that are either normally open or normally closed under pressure. One gauge is required for each slave cylinder.



Figure 6. Slave Cylinder Gauge

Actuation Hoses

1/4" (6 mm) diameter Actuation hoses are used to provide pressure to the valve to actuate the system. The Actuation hoses are also used in multi-cylinder systems to convey pilot pressure at 116 psig (8 bar) from the prior cylinder-valve to the next cylinder-valve. The hoses include quick connect couplings which allows ease of installation and maintenance.

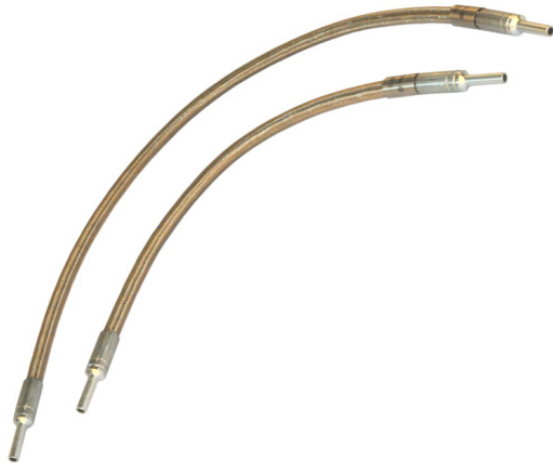

Figure 7. Actuation Hose

Discharge Hoses

3/4" (20 mm) diameter Discharge hoses route the agent from the cylinder-valve assemblies to the system piping. Hoses connect to the discharge outlet of the agent cylinder-valve and terminate at the system piping or discharge manifold.

Hoses with 90° to 90° couplings are typically used in conjunction with manifolds to allow for easy adjustments. Hoses with Straight to Straight couplings should be used in single cylinder applications.



Figure 8. Discharge Hoses

Manifold Check Valve

Manifold Check Valve are required to be installed where the discharge hose connects with a manifold in order to prevent backflow to the cylinder-valve. Manifold check valves have 3/4" (20 mm) BSP male threads at both ends and are marked with the direction of agent flow.

The pre-built Natura IGS manifolds are shipped with Manifold Check Valves pre-installed, one per stub.

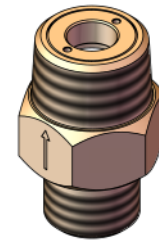

Figure 9. Manifold Check Valve

Note: If procuring a manifold elsewhere, only approved Natura IGS Manifold Check valves may be used. Ensure each discharge connection uses a manifold check valves.

Manifolds

2" (50 mm) diameter Manifolds of varying lengths in single or double row configuration are available for the Natura IGS. The Manifolds are available for 80 and 140 Liter cylinders.

Manifolds includes a 3/4" Manifold Check valve at each inlet port. Manifolds can be coupled together using a 2" BSP Manifold Coupling and capped off using a 2" BSP Manifold End-cap.



Figure 10. Single Row Manifold



Figure 11. Double Row Manifold

Selector Valves (Stop Valve)

Selector valves route agent from a central cylinder bank to the specific hazard where fire has been detected. Selector valve actuators operate pneumatically using agent pressure routed from the manifold via a pressure regulator on the back-plate manifold and the respective back-plate solenoid valve.

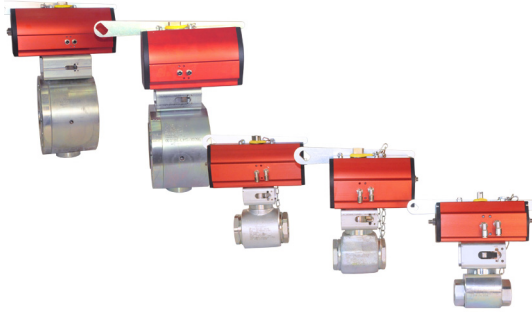

Figure 12. Selector Valve

Selector valves are 2-way ball valves with full bore. Selector valves of 1", 1 1/2", and 2" size have BSP threaded inlet and outlet ports for connection to the distribution piping. 3" and 4" Selector valves use DIN 2638 flanges for this connection.

The solenoids are mounted on a back-plate with tamper proof screws and cannot be removed.

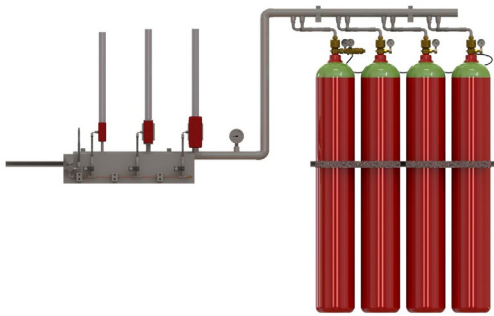

Figure 13. Selector Valve Setup

Lockout Valve

A lockout valve is a manually operated valve installed between the agent manifold and the discharge pipe network leading to the protected area. Lockout valves can be locked in the closed position to prevent agent from discharging into the protected area.

Lockout valves can be installed at the end of the manifold or, if a common manifold protects multiple hazards, downstream of each selector valve. Lockout valves include a limit switch. The limit switch must be wired to the control panel to indicate a trouble if the valve is closed.

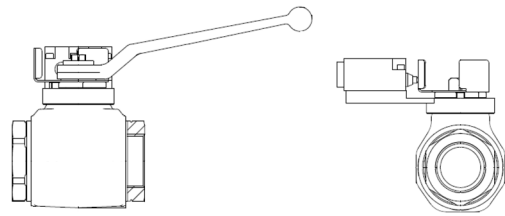

Figure 14. Lockout Valve

Agent Discharge Nozzles

The Natura IGS offers nozzles with 360° and 180° discharge patterns which can be mounted in either upright or pendant style. The number and size of the orifice on each nozzle is custom calculated using the Flow Calculation Software Suite version 4.0 and higher.



Figure 15. Nozzles

Cylinder Racking

The racking system for the Natura IGS is modular and can be adjusted to fit any number of cylinders in a variety of row combinations.

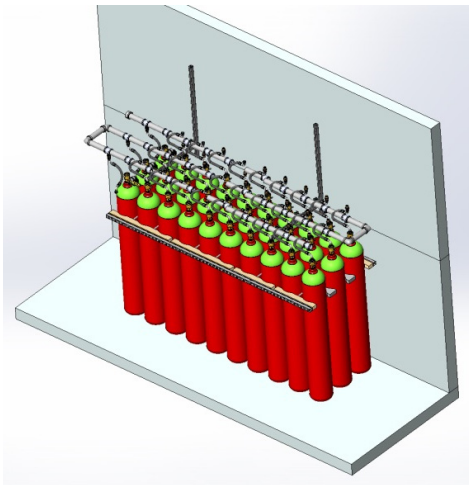

Figure 16. Racking Example

Quick Connect Cables

Quick Connect cables provide an expedient method of wiring the pressure gauges of the Release Unit and Slave Cylinder Gauge Assemblies. The open contacts of the supervisory pressure switch are connected in parallel through Quick Connect cables in a daisy chain form.



Figure 17. Quick Connect Cables

Accessories:

Bleeder Valve:

A Bleeder Valve should be installed on a Pilot Line in the unused actuation hose connection in the last cylinder of a cylinder bank. The end-of-line leak/vent valve prevents a possible gradual pressure build-up in the pilot line should the solenoid release unit develop a leak, thus preventing an unintended system discharge. The bleed valve includes a Quick Connect fitting for ease of installation and maintenance.



Figure 18. Bleeder Valve

Manifold Safety Device:

The manifold safety device consists of a safety disc housed in a threaded body. The safety disc is designed to burst at a pressure of 90-100 Bar. Manifold safety devices have an NPT fitting on the side that connects to the manifold and a BSPT threading on the side that would connect to the venting pipe if applicable.

The Manifold Safety Device should be used on manifolds with selector valves and lockout valves where the design of the system creates a closed section of piping. The safety outlet is installed in the piping upstream of the valve(s) to prevent over pressurization in the event of entrapment of Agent in the closed pipe segment. The outlet on the safety device may also be piped to vent directly to atmosphere or to vent to the pipe network downstream of any selector valve.

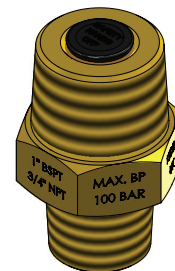

Figure 19. Manifold Safety Device

Pressure Switch:

The pressure operated switch uses the pressure of the discharging agent for activation should be connected to the distribution piping. The agent actuates a pressure operated stem which toggles the electrical switch. Each switch can also be operated manually by pulling up on the stem. These switches are used to annunciate alarms, to shut down ventilation and/or other electrical equipment and to turn on electrical automatic dampers or other electrical equipment. Each pressure switch must be manually reset, by pushing down on the stem to return the switch to the set position. The minimum operating pressure required is 50 PSI. The toggle on the pressure switch can be set to either N.O. to close or N.C. to open contact transfer upon operation.



Figure 20. Pressure Switch

Pressure Operated Trip:

The pressure operated trip, is connected to the distribution piping and utilizes agent pressure for actuation. The agent pressure displaces a spring-loaded piston to disengage a holding ring from the stem connected to the piston.



Figure 21. Pressure Operated Trip

Main & Reserve Systems

The Natura IGS supports a 'Reserve' bank of cylinders, equal in quantity and size to the main bank. A reserve system can minimize downtime prevent service interruption in case of a discharge. A reserve system is also recommended when using selector valves and when downtime cannot be tolerated should a discharge occur.

The system with main and reserve cylinders are connected to Suppression Control Panel through a Main/ Reserve Transfer Switch.

Main & Reserve Transfer Switch:

The main & reserve transfer switch, is installed on systems having main and reserve cylinders. Placing the switch in either the "main" or "reserve" position provides uninterrupted fire protection capability during system maintenance or in the event of a system discharge.



Figure 22. Main and Reserve Transfer Switch

Control Panel

For systems covering a single zone, use the Kidde Fire Systems AEGIS™ control unit.

Multi zone systems using selector valves require an addressable control panels such as the Kidde Fire Systems ARIES™ or the ARIES NETLink control unit.

Note: The release units of the Natura system must be listed with the suppression control panel.

Flow Calculation Software Version 4.0:

Using the parameters listed below the Flow Software calculates pressure drops, pipe sizes, orifice sizes and vent area requirements:

- Inert agent selection
- System Pressure 200 Bar/300 Bar
- Cylinder size 80 L
- Discharge time 60 Sec./120 Sec.
- Nozzle Selection 180°/360°
- Single Zone/Multi Zone Systems

Parts List

Description	Part Number
Kidde Fire Systems 80L Cylinder with IG-100 to 200 bar	38-428021-100
Kidde Fire Systems 80L Cylinder with IG-100 to 300 bar	38-428031-100
Kidde Fire Systems 80L Cylinder with IG-55 to 200 bar	38-428021-055
Kidde Fire Systems 80L Cylinder with IG-55 to 300 bar	38-428031-055
Release Unit	
Release Unit 400 Series - 200 Bar, Manual / Electric, N.O. Gauge	38-400001-001
Release Unit 400 Series - 300 Bar, Manual / Electric, N.O. Gauge	38-400001-003
Slave Cylinder Gauge	
Slave Cylinder Gauge Assembly - 200 Bar, N.O.	38-400005-001
Slave Cylinder Gauge Assembly - 300 Bar, N.O.	38-400005-003
Quick Connect Cables	
L Plug x 2 Cable, Dual Core 0.013 x 11.8" (0.34 x 300mm) x Quick Connects (Male & Female)	38-400005-100
Gauge Signal Line - Quick Connect Terminal Plug (MALE)	38-400005-101
Gauge Signal Line - Quick Connect (MALE) Connector with 3m Fly lead (Dual Core Cable)	38-400005-102
Quick Connect (Male) x Dual Core 0.013 x 39.4" (0.34 x 1000mm) Fly-Lead	38-400005-103
Quick Connect (Female) x Dual Core 0.013 x 39.4" (0.34 x 1000mm) Fly-Lead	38-400005-105
Discharge Accessories	
Manifold Check Valve 3/4", BSP	38-400002-002
15.75" Actuation Hose with Quick Connect Fitting, Straight to Straight	38-401110-400
19.68" Actuation Hose with Quick Connect Fitting, Straight to Straight	38-401110-500
23.62" Actuation Hose with Quick Connect Fitting, Straight to Straight	38-401110-600
23.62" Actuation Hose with Quick Connect Fitting, Straight to 90°	38-401130-600
27.56" Actuation Hose with Quick Connect Fitting, Straight to 90°	38-401130-700
Discharge Hose 3/4" Dia., 16.1" (410 mm) Length, 90° to 90°	38-400330-410
Discharge Hose 3/4" Dia., 20.1" (510 mm) Length, 90° to 90°	38-400330-510
Discharge Hose 3/4" Dia., 11.8" (300 mm) Length, Straight to Straight	38-400110-300
Pilot Line Bleed Valve (for last cylinder)	38-400007-001
Pressure Switch, 3 Pole Double Throw	81-486536-000
Pressure Switch, 3 Pole Single Throw (Ex. Proof)	81-981332-000
Pressure Trip	81-874290-000
Main-to-Reserve Transfer Switch	84-802398-000

Description	Part Number
Selector Valves	
1" Selector valve, DN 25, 8-10 Bar Actuator	22-37140-025
1 1/2" Selector valve, DN 40, 8-10 Bar Actuator	22-37140-040
2" Selector valve, DN 50, 8-10 Bar Actuator	22-37140-050
3" Selector valve, Flange DN 80, 8-10 Bar Actuator	22-37140-080
4" Selector valve, Flange DN 100, 8-10 Bar Actuator	22-37140-100
Back-Plate Manifold - 2 Area, Selector Valve Control, 8 Bar	01-3508-0002
Back-Plate Manifold - 3 Area, Selector Valve Control, 8 Bar	01-3508-0003
Back-Plate Manifold - 4 Area, Selector Valve Control, 8 Bar	01-3508-0004
Back-Plate Manifold - 5 Area, Selector Valve Control, 8 Bar	01-3508-0005
Back-Plate Manifold Hose	01-3273-1200
Pressure Regulator - 300 Bar to 8 Bar	01-6017-0000
Lockout Valves	
Valve, 1" NPT Lockout (Isolation)	38-409830-005
Valve, 2" NPT Lockout (Isolation)	38-409830-007
Valve, 3" NPT Lockout (Isolation)	38-409830-009
Valve, 4" NPT Lockout (Isolation)	38-409830-010
Discharge NPT Nozzles	
Nozzle Assembly, 1/2" NPT, 360°	38-407100-XXX
Nozzle Assembly, 3/4" NPT, 360°	38-407200-XXX
Nozzle Assembly, 1" NPT, 360°	38-407300-XXX
Nozzle Assembly, 1-1/2" NPT, 360°	38-407400-XXX
Nozzle Assembly, 1/2" NPT, 180°	38-407500-XXX
Nozzle Assembly, 3/4" NPT, 180°	38-407600-XXX
Nozzle Assembly, 1" NPT, 180°	38-407700-XXX
Nozzle Assembly, 1-1/2" NPT, 180°	38-407800-XXX
Discharge Delay, Siren, and Associated Accessories	
108 cu. in. Nitrogen Pilot Cylinder with Supervisory Pressure Switch	06-129773-001
1040 cu. in. Nitrogen Pilot Cylinder w/pressure switch	90-101040-200
30 Second Nitrogen Discharge Delay Kit	38-401140-030
60 Second Nitrogen Discharge Delay Kit	38-401140-060
Siren, Nitrogen Pressure Operated	90-981574-001
Male Connector, 5/16" Flare x 1/8" NPT	WK-699205-010
Mounting Bracket, Nitrogen Pilot Cylinder 108 cu. in.	WK-877845-000
Actuation Hose, 30"	WK-264986-000
Cylinder Strap, Nitrogen Pilot Cylinder 1040 cu. in.	WK-270014-000
Discharge Head, Plain Nut	WK-872450-000

Description	Part Number
Discharge Delay, Siren, and Associated Accessories (continued)	
Flexible Hose, 3/4" Outlet	WK-251821-000
Electric Control Head, 24 VDC Kit with Control Head Monitor	85-890181-000
Lever Operated Control Head	WK-870652-000
Lever/Pressure Operated Control Head	82-878751-000
Manifold Equipment	
80 Liter BSP Manifold, with manifold check valvesn for each stub	38-351000-0XX
2" BSP Manifold Coupling	38-400020-100
2" BSP Manifold End Cap	38-400020-101
2" Adapter, BSPT (F) to NPT (F)	38-351000-001
Bracket for 80L Cylinder manifold 1 Row 200mm (inc 2" Clamp)	01-8160-0200
Bracket for 80L Cylinder Manifold 2 Rows 520 mm (inc 2" Clamp)	01-8160-0520
Bracket for 80L Cylinder Manifold 3 Rows 830 mm (inc 2" Clamp)	01-8160-0830
2" Pipe Clamp ø58.7 - ø63.5 mm	01-8143-0000
Cylinder Racking Kits	
Unistrut Cyl Wall Bracket - 400mm -1850mm	01-812X-1000
Clamping Bar 1 x 2 for 80 L Cyl (Front)	03-8266-0000
Clamping Bar 1 x 3 for 80 L Cyl (Front)	03-8267-0000
Wooden Spacer 1 x 2 for 80 L Cyl (Rear)	03-8162-0000
Wooden Spacer 1 x 3 for 80 L Cyl (Rear)	03-8163-0000
Wooden Spacer 2 x 2 for 80 L Cyl (Center)	03-8164-0000
Wooden Spacer 2 x 3 for 80 L Cyl (Center)	03-8165-0000
Single Clamp 80L Cyl Galvanized Steel	01-8131-0000
Clamping Bolt, 2 Row, 80L - 715mm Long	01-8337-0200
Clamping Bolt, 3 Row, 80L - 1030mm Long	01-8337-0300
Endcover, White PVC 34 X 40 mm	01-8131-0002
Distance Pipe 3/4" + Washers 80L	03-8331-0000

EXPORT INFORMATION (USA)

Jurisdiction: EAR

Classification: EAR99

This document contains technical data subject to the EAR.

All trademarks are the property of their respective owners.

This literature is provided for informational purposes only. KIDDE-FENWAL, INC. believes this data to be accurate, but it is published and presented without any guarantee or warranty whatsoever. KIDDE-FENWAL, INC. assumes no responsibility for the product's suitability for a particular application. The fire suppression system design, installation, maintenance, service and troubleshooting must be performed by trained, authorized Kidde Fire Systems distributors for the product to work correctly. If you need more information on this product, or if you have a particular problem or question, contact: KIDDE-FENWAL, INC., Ashland, MA 01721 USA, Telephone: (508) 881-2000.